

POHLAD ZHORA M 1:50

TOP ELEVATION
OBERANSICHT

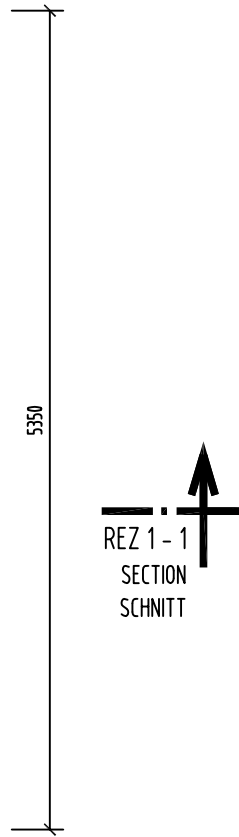

REZ 2-2 M 1:50 LONGITUDINAL SECTION QUERSCHNITT

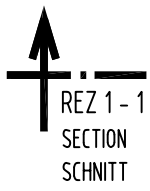
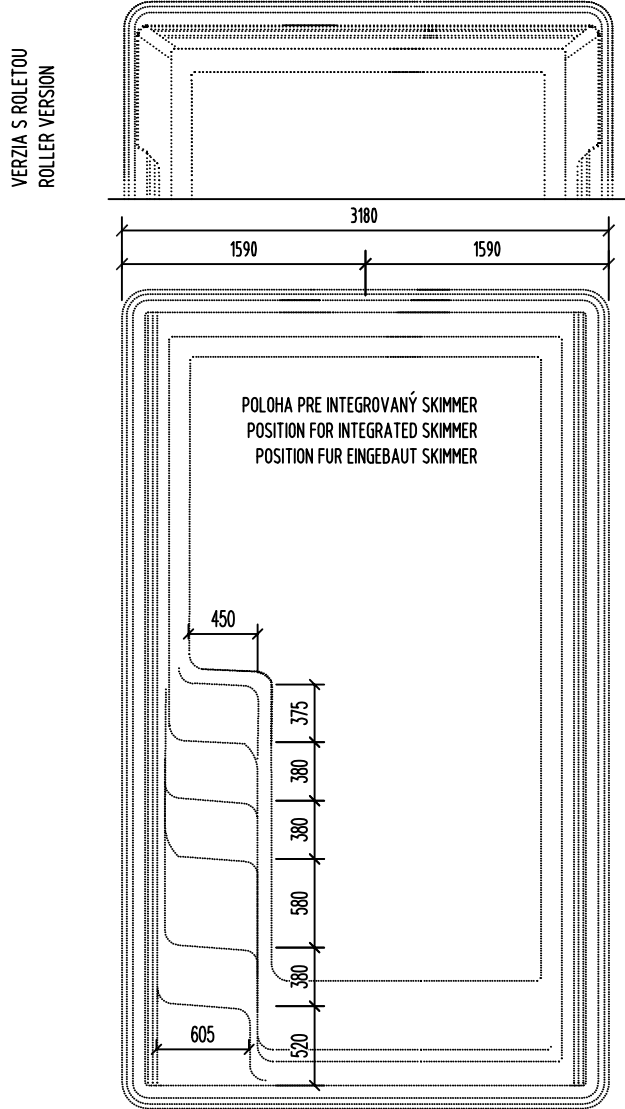
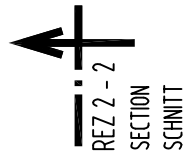
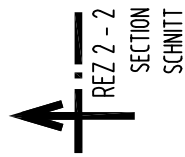
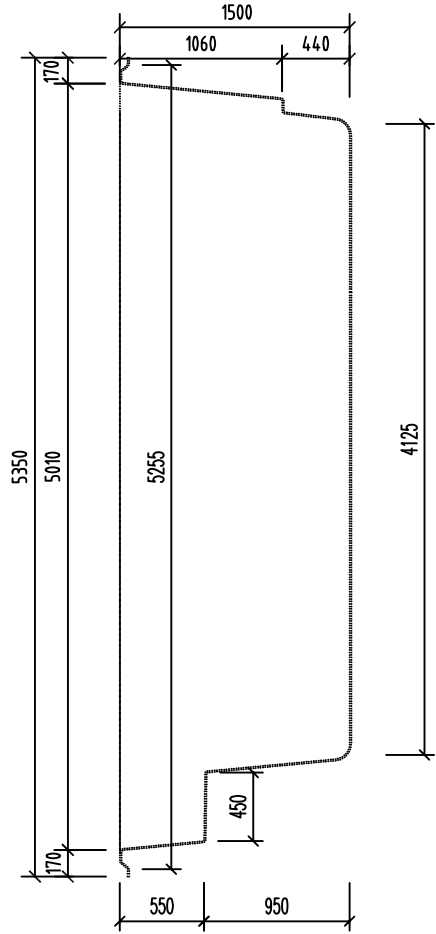

REZ 1-1 M 1:50

CROSS SECTION
QUERSCHNITT

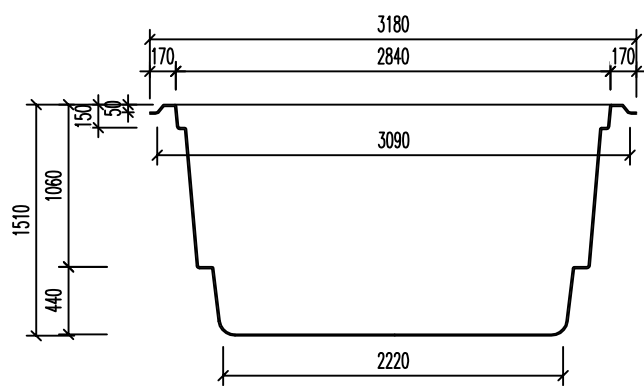

DETAIL ÚPRAVY INTEGROVANÝ SKIMMER M 1:25 DETAIL FOR INTEGRATED SKIMMER

FIXÁCIA PLAVÁKU HLADINY
FIXATION FOR WATER LEVEL FLOAT
ELEMENT FIXIERUNG FÜR WASSERHOHE

D63 NAPOJENIE SANIA SKIMMERA
D63 SKIMMER-SAUGANSCHLUSS
D63 SKIMMER-OUTLET FITTING

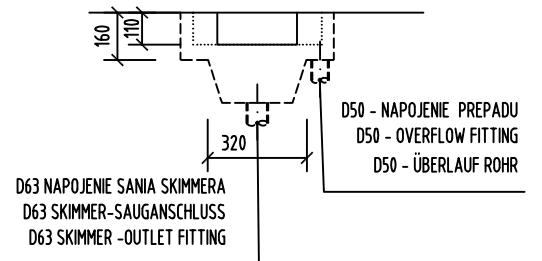

D63 NAPOJENIE SANIA SKIMMERA
D63 SKIMMER-SAUGANSCHLUSS
D63 SKIMMER-OUTLET FITTING

D50 - NAPOJENIE PREPADU
D50 - OVERFLOW FITTING
D50 - ÜBERLAUF ROHR

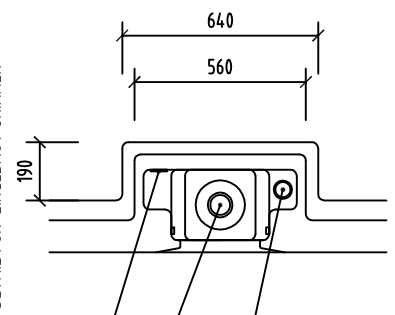

D50 - NAPOJENIE PREPADU
D50 - OVERFLOW FITTING
D50 - ÜBERLAUF ROHR

POZNÁMKA / NOTE / ANMERKUNG :

HRÚBKBA STENY BAZÉNA JE CCA. 10 MM
TOLERANCIA PRESNOSTI 7 - 10 MM

THICKNESS OF THE SIDEWALL OF SWIMMING POOL IS APPROX. 10 MM.
MEASURED WITH TOLERANCE RATE 7 - 10 MM

DIE SCHWIMMBADWAND DÜCKE IS CA. 10 MM.
DUCKENTOLERANZ IST 7 - 10 MM.

POOL HIGH FOR CONTAINER FOR SEA TRANSPORT IS 3080MM.

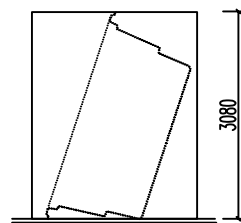

POOL HIGH FOR CONTAINER FOR SEA
TRANSPORT IS 3090MM.

NÁZOV VÝKRESU:
DRAWING NAME:
ZEICHNUNG NAME:

CLASSIC 53
GEOMETRIA BAZÉNA
GEOMETRY OF SWIMMING POOL
SCHWIMMBAD GEOMETRIE

COMPASS
enjoy the moment

www.compasspools.eu

KRESLIL: ING. PETER KALETA DÁTUM: 12/2022

DRAWN BY / ZEICHNER: DATUM / DATUM:

MIERKA: SCALE/MASSTABE: 1:50 FORMÁT: A3

VERZIA: VERSION: 1 ČÍSLO: 1

DRAWING NUMBER: ZEICHNUNG NUMBER: